

# Installation Instructions

GRP Sheeting

## Product Handling and Storage Instructions for All Products

- Store sheeting in a dry location and protect from possible wind damage prior to installation.
- Sheeting should not be dragged across objects or other products as it may affect the performance and aesthetics of the roof sheet.
- Care should be taken when loading the translucent roofing onto the roof to avoid bending or distortion of the sheet.
- Sheeting that becomes wet in bundles and is required to be stored should be separated and dried prior to storage.

## Recommended Installation Guidelines

- Sheeting may be cut using an abrasive disc or fine tooth saw (use protection gloves and approved face mask).
- GRP Translucent roofing is not designed to support foot traffic and unless specifically excluded in AS 1562.3:2006, clause 2.4.3 requires the use of safety mesh under all translucent roof sheeting. Refer to Figure 5.
- Alsynite NZ Purlin barrier strip must be installed between the translucent roof sheeting and the safety mesh at the purlin line. Refer to Figure 5.
- Ensure the purlins are correctly spaced and that they are in line.
- GRP fibreglass roofing should always be installed over the main roof cladding at both lapping edges. Refer to Figure 1.

- Ensure the weight/thickness of the sheet combined with the selected roofing profile will meet the spanning requirements.  
*Contact Alsynite NZ Ltd for specific design advice or refer Load Span Capability Chart - Page 23.*
- Ensure that the correct weathering surface of the sheeting is uppermost as the durability and any warranty is dependent on placing the sheet the correct side up.

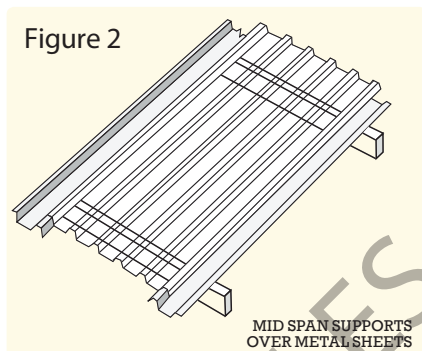

- Where two translucent roof sheets are laid side by side, the mid span support shall extend under the metal roofing sheet by a minimum 400mm with fastening through at least two ribs of the metal roofing on either side of the GRP sheet.
- Mid span supports shall not be used where more than two translucent sheets are adjacent to one another.
- If more than two sheets of Topglass® Roofing products are to be used side by side, contact Alsynite NZ Ltd for specific guidelines.
- Where roof installations require Topglass® or Topclad™ to be laid side-by-side, it is recommended that the use of Lap Seal Tape be implemented in these situations, therefore preventing possible water ingress over the laps.

## Stop Ends

Install stop ends to the top of the translucent sheeting as follows.

### Method 1

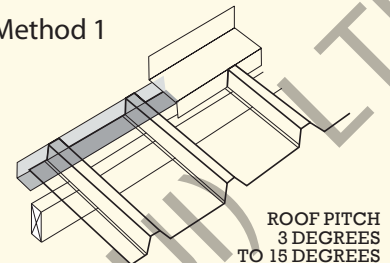

Use a right-angled folded flashing to the full height of the corrugation or rib, fixed with rivets and sealant.

- Severe conditions: Use 0.9mm aluminium.
- Moderate conditions: Use pre-painted metal.

Note: This can also be used in an exposed site or high or very high wind zone for steeper pitched roofs.

### Method 2

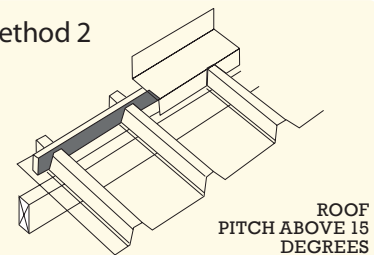

Use Alsynite NZ Ltd approved closed cell profiled foam strip fitted close to the screw fixing points.

## Sealants

The use of silicone should be restricted to end laps only as when set the sealant restricts the ability of the sheet to expand and contract. The use of sealants under side laps is not recommended. In some particular building designs i.e. curved roofing and where the pitch may fall below the recommended minimum pitch, Alsynite NZ Ltd Lap seal tape can be applied to lapping edges. Expansion and contraction of dissimilar roofing materials should be taken into prior consideration.

## Rainwater Gutters

GRP roof sheeting should not be drained into unpainted or galvanised gutters.

Figure 1

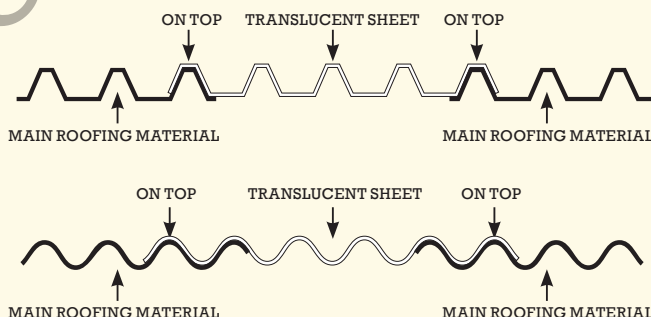



## End Laps

- Minimum recommended length of end lap of GRP sheets and/or with metal profile sheeting is 200mm.
- Position of lap over purlin - it is recommended the bottom end of the lap sheet be within 50mm of the lower side of the purlin.
- Position of the seal - the bottom bead should be within 25mm from the bottom of the top sheet in lap, and the top bead of seal within 50mm of the top of the bottom sheet.

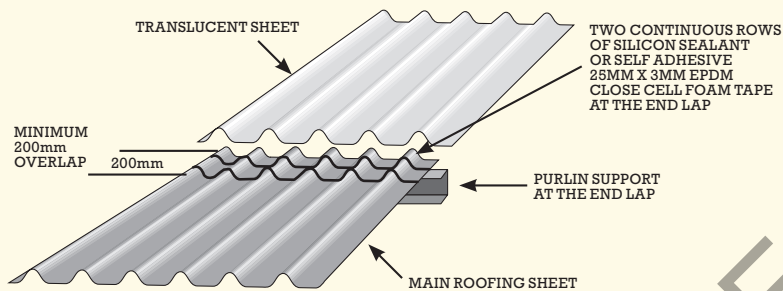

Other fastener methods such as 32mm Weatherlok washers maybe suitable based on sheet length and load characteristics. Alsynite NZ Ltd should be contacted for further clarification and advice.

- All fastener holes should be pre-drilled over-size to accommodate the expansion and contraction of the sheets as follows:

Sheets up to 6m	8mm Ø hole
Sheets 6m to 9m	10mm Ø hole
Sheets 9m to 12m	12mm Ø hole
Sheets 12m to 28m	16mm Ø hole

Note: It is important to centre the fixing in the oversize hole to ensure the sheet has equal movement around the fixing.

Note: Where wind loads exceed 1.5kPa, contact Alsynite NZ Ltd for specific design advice. Do not overdrive the fasteners so that deformation of the sheet occurs.

## Side Lap Fixing

Side laps should be fixed at a maximum spacing of 600mm to prevent wind uplift and leakage, and these fixings shall be through the top of the rib.

- When fixing GRP to metal, pre-drill the appropriate oversize hole in the GRP and screw through the centre of the hole into the metal using a self drilling hex head screw 12g or 14g complete with load spreading washer and 36mm EPDM sealing washer. Refer to Figure 3.

**Figure 3**

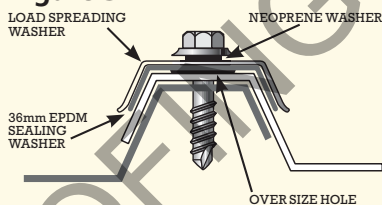

- When fixing GRP to GRP use a bulbrite rivet 6-4w through the top of the rib of the GRP sheets. Refer to Figure 2.

**Figure 4**

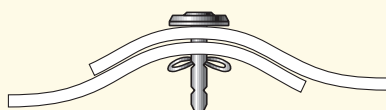

## Fastener and Sealing Washer Recommendations

The fastener shall be as for the main roof cladding and will be used in conjunction with a Alsynite NZ Ltd approved load spreading washer constructed of 0.95mm unpainted/prepainted metal or 1.2mm aluminium to match the main cladding material. In a highly corrosive environment, consideration should be given to the use of stainless steel or other appropriate corrosive resistant material.

Inserted under the load spreading washer will be a 36mm EPDM sealing washer which is to be correctly seated to provide an effective seal. Fasteners should be inserted through the top centre of the rib/corrugation.

**Figure 5**

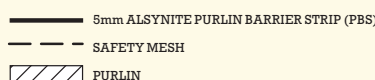
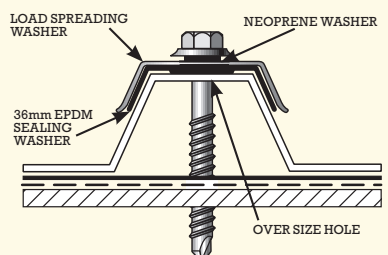

## Fastener Pattern

- Corrugated profile end supports and end laps: Fix side laps and every 2nd corrugation.
- Corrugated profile internal supports or purlins: Fix side laps and every 3rd corrugation.
- 5 rib low trapezoidal profiles (19mm to 30mm): On all purlins fix every rib.
- High trapezoidal profiles (50mm to 120mm): On all purlins fix every rib.
- 7 to 8 rib medium trapezoidal profiles (33mm to 49mm) end support and end laps: Fix every rib.
- 7 to 8 rib medium trapezoidal profiles (33mm to 49mm) internal support or purlins: Fix side laps and every 2nd rib.
- Deck profiles - fix every rib.

## Further Technical Assistance

The installation instructions are a guide to assist with installation of translucent roof sheeting. However these should be read in conjunction with the full technical information contained in the Alsynite NZ Technical Catalogue. For non-standard building design such as draped curve roofs, contact Alsynite NZ Ltd for technical advice prior to ordering product or commencing the project.

NOTE: GRP - Glass Fibre Reinforced Polyester